

Avenue Wall 300 II

THORN

E7717153 / 96258554 AVENUE W300 II LED 12L35 730 CL2

ISO 9223 C3	IP65	IK09		CE			Ta25
----------------	------	------	--	----	--	--	------

Avenue Wall 300 II

Avenue Deco wall light. Class II electrical, IP65, with opal polycarbonate bowl. Complete with integral control gear and 14W LED source. Complete with 3000K LED

Dimensions: 313 x 176 x 362 mm

Luminaire input power: 15 W

Weight: 3.42 kg



TLG_AVNE_F_W300PDBUNLIT.jpg

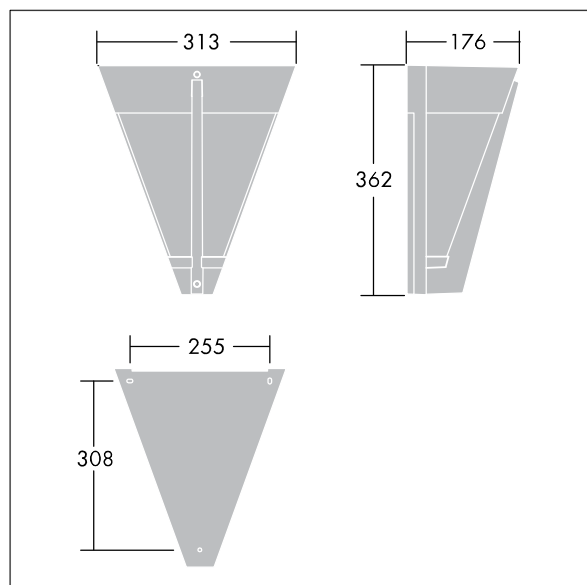

TLG_AVED_M_LDW300.wmf

This product contains a light source of energy efficiency class D.

All values marked with an * are rated values. Thorn uses tried and tested components from leading suppliers, however there may be isolated instances of technology-related failures of individual LEDs during the rated product lifetime. International standards set the tolerance in initial flux and connected load at $\pm 10\%$. Unless stated otherwise, the values apply to an ambient temperature of 25°C.

Thorn Lighting is constantly developing and improving its products. The right is reserved to change specifications without prior notification or public announcement.
© Thorn Lighting