

# Plurio

# THORN

E7753918 / 96260704 PLD O 18L70 R/S BPSW CL2 N4M D60 L740



## Plurio

Decorative, post-top lantern with LED package with electronic driver. Class II electrical, IP66, IK08. Base in cast aluminium, powder coated silver-grey. Canopy in original shape, made from aluminium textured silver-grey (close to RAL9006). UV stabilised polycarbonate clear diffuser with anti-glare prisms. Internal symmetric reflector. Equipped with 50% power reduction circuit, effective 3 hours before and 5 hours after a calculated midnight. It can be deactivated at installation with an easily accessible internal switch. Supplied complete in one box. Complete with 4000K LED

To be post top mounted on a spigot of  $\text{Ø}60\text{mm}$ , length 75mm. Pre-cabled with 4m HO5-W F 2 x 1.5mm<sup>2</sup> cable.

Dimensions:  $\text{Ø}564 \times 567 \text{ mm}$   
Luminaire input power: 39 W  
Weight: 7.8 kg  
Scx: 0.074m<sup>2</sup>  
Luminaire efficacy: 121 lm/W



TLG\_PLRO\_F\_LEDSYM.jpg

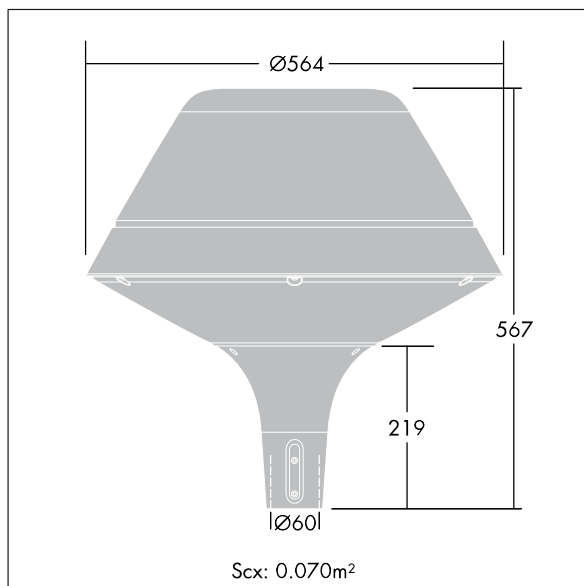

TLG\_PLRO\_M\_LMPShd60.wmf

This product contains a light source of energy efficiency class D.

All values marked with an \* are rated values. Thorn uses tried and tested components from leading suppliers, however there may be isolated instances of technology-related failures of individual LEDs during the rated product lifetime. International standards set the tolerance in initial flux and connected load at  $\pm 10\%$ . Unless stated otherwise, the values apply to an ambient temperature of 25°C.

Thorn Lighting is constantly developing and improving its products. The right is reserved to change specifications without prior notification or public announcement.  
© Thorn Lighting

**Plurio**

**E7753918 / 96260704 PLD O 18L70 R/S BPSW CL2 N4M D60 L740**

**THORN**