

EP 145

96269172 EP 145 LED 24L50 SC 740 RCU/MTP F5M

ISO 9223 C5	IP66	IK08					
----------------	------	------	--	--	--	--	--

EP 145

A 19th Century styled post top lantern with 24 LEDs driven at 500mA with Street & Comfort optic. Class II electrical, IP66, IK08. Body: copper, treated. Canopy: GRP/Polyester, copper finish. Enclosure: 5mm thick tempered glass. Pre-wired with 5m cable. Complete with 4000K LED

Dimensions: 420 x 420 x 767 mm

Luminaire input power: 38 W

Weight: 10.1 kg

Scx: 0.145 m²



TLG_EP14_F_LEDMP CoppDB.jpg

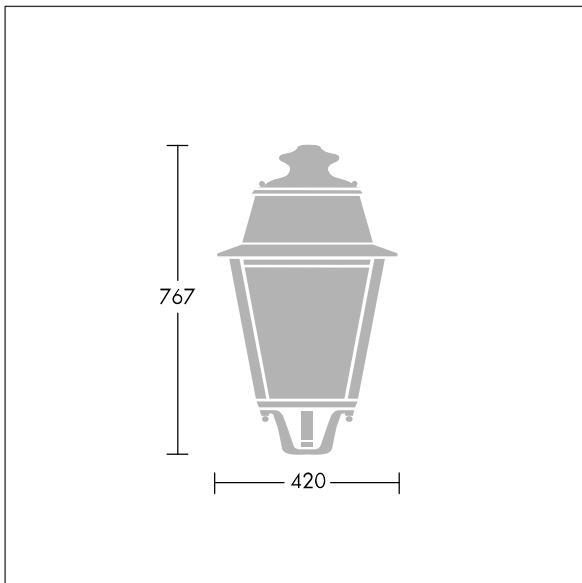

TLG_EPLS_M_LD1.wmf

This product contains a light source of energy efficiency class D.

EP 145

96269172 EP 145 LED 24L50 SC 740 RCU/MTP F5M

THORN