

EP 145

96269262 EP 145 LED 36L70 BP NR 730 RS/MTP

ISO 9223	C5	IP66	IK08					
----------	----	------	------	--	--	--	--	--

EP 145

A 19th Century styled post top lantern with 36 LEDs driven at 700mA with Narrow Road optic. Integral power reduction function which dims down to 50% power, effective 3 hours before and 5 hours after a calculated midnight. Class II electrical, IP66, IK08. Body: stainless steel, painted black (close to RAL9005). Canopy: GRP/Polyester, black (close to RAL9005) finish. Enclosure: 5mm thick tempered glass. Complete with 3000K LED

Dimensions: 420 x 420 x 767 mm

Luminaire input power: 77 W

Weight: 8.6 kg

Scx: 0.145 m²



TLG_EP14_F_LEDMPBLKPDB.jpg

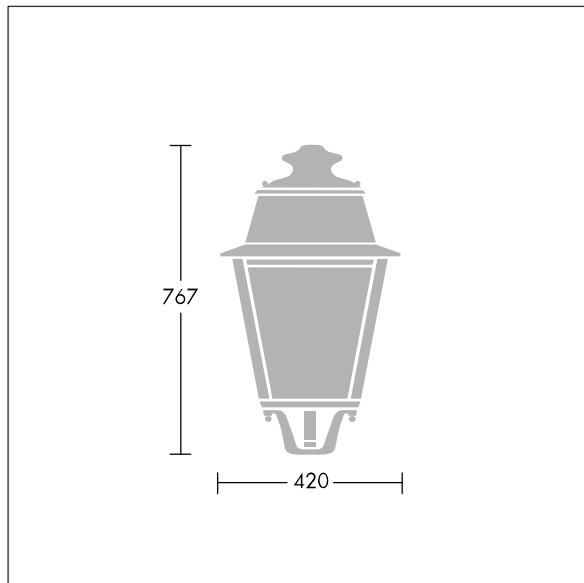

TLG_EPLS_M_LD1.wmf

This product contains a light source of energy efficiency class D.