

# Thor

# THORN

96643966 TR 72L50-730 SC BP CL2 FD W9 L60E

ISO 9223	C5	IP66	IK08						T <sub>a</sub> 0 +25
----------	----	------	------	--	--	--	--	--	-------------------------

## Thor

A large size, smart urban LED lantern with 72 LEDs driven at 500mA with Street & Comfort optic and UV stabilised polycarbonate dome with anthracite finish (close to RAL7043). Class II electrical, IP66, IK08. Body, bracket and ring: die-cast aluminium (AS12U, LM6 equivalent, EN AC-44300) treated against corrosion, powder coated anthracite (close to RAL7043). Enclosure: 4mm toughened flat glass. Screws and closing set: stainless steel. Pre-wired with 9m cable. Side entry mounting to Ø60mm spigot, tilt 0°, adjustable from -15° to +10°. Equipped with power reduction circuit, effective 3 hours before and 5 hours after a calculated midnight. Complete with 3000K LED.

Dimensions: Ø577 x 155 mm  
Luminaire input power: 109 W  
Luminaire luminous flux: 14511 lm  
Luminaire efficacy: 133 lm/W  
Weight: 14.8 kg  
Scx: 0.044 m<sup>2</sup>



TLG\_THRL\_F\_MLEFD0.jpg

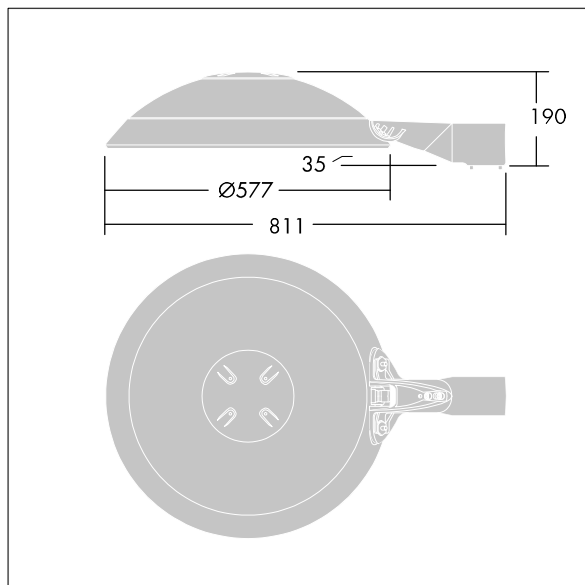

TLG\_THOR\_M\_BRK.wmf

This product contains light sources of energy efficiency class D.

All values marked with an \* are rated values. Thorn uses tried and tested components from leading suppliers, however there may be isolated instances of technology-related failures of individual LEDs during the rated product lifetime. International standards set the tolerance in initial flux and connected load at ±10%. Unless stated otherwise, the values apply to an ambient temperature of 25°C.

Thorn Lighting is constantly developing and improving its products. The right is reserved to change specifications without prior notification or public announcement.  
© Thorn Lighting

**Thor**

**96643966 TR 72L50-730 SC BP CL2 FD W9 L60E**

**THORN**