

EP 445

96631766 EP445 36L70-740 ROTO BPS CL2 W5M MTP

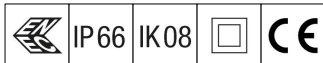

EP 445

A 19th Century style lantern with 36 LEDs with switchable drive current and symmetrical optic. Post top mounting. Equipped with power reduction circuit, profile selected by rotary switch. Class II electrical, IP66, IK08. Body: die-cast aluminium, painted black (close to RAL9005) textured. Enclosure: 4mm thick extra clear glass. Pre-wired with 5m cable. Complete with 4000K LED

Dimensions: 436 x 436 x 695 mm

Luminaire input power: 78 W

Weight: 9.7 kg

Scx: 0.19 m²



TLG_EP44_F_MTP.jpg

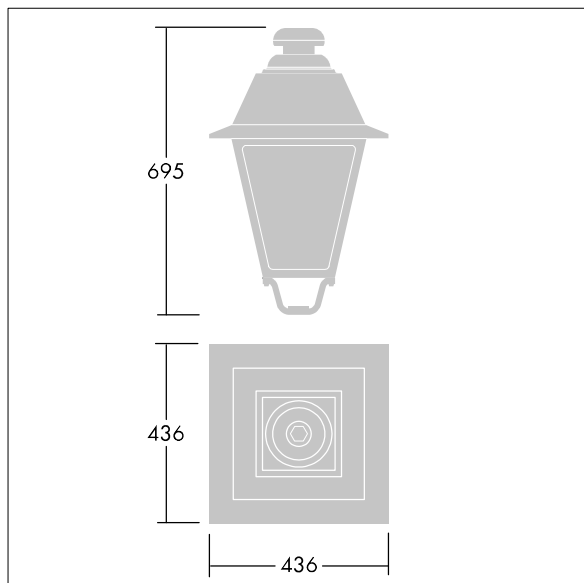

TLG_EP44_M_MTP.wmf

This product contains a light source of energy efficiency class D.

EP 445

96631766 EP445 36L70-740 ROTO BPS CL2 W5M MTP

THORN