

96276898 VICIA2 72L70-740 NR BP 3550 HFX CL2 ->



Victoria

A large size LED street and urban luminaire, in a modern and timeless design. 72 LEDs driven at 700mA with Narrow Road optic. DALI dimmable LED driver. Class II electrical, IP65. Body in aluminium, powder coated Traffic white RAL9016. Enclosure: toughened flat glass. Luminaire to be suspended using brackets (Ø27G), post top, or wall mounted. Tool-free electrical connection via 2 x 2.5 mm² terminal block. Equipped with 50% power reduction circuit, effective 3 hours before and 5 hours after a calculated midnight. Pre-wired with 10m, 4 core cable. Complete with 4000K LED

Must be used in conjunction with a canopy (see Victoria Canopies section), to be ordered separately.

Dimensions: Ø705 x 435 mm
 Luminaire input power: 159 W
 Weight: 14.1 kg
 Scx: 0.228 m²



TLG_VCTA_F_PDB.jpg

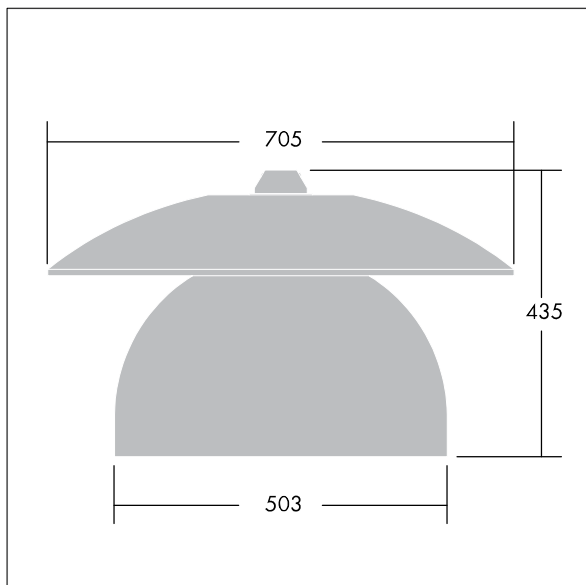

TLG_VCTA_M_SWLD2.wmf

This product contains light sources of energy efficiency classes D, F.

Victoria

96276898 VICIA2 72L70-740 NR BP 3550 HFX CL2 ->

THORN