

Victoria

THORN

96276879 VICIA1 12L35-740 NR BP 3550 HFX CL2 ->



Victoria

A small size LED street and urban luminaire, in a modern and timeless design. 12 LEDs driven at 350mA with Narrow Road optic. DALI dimmable LED driver. Class II electrical, IP65. Body in aluminium, powder coated Traffic white RAL9016. Enclosure: toughened flat glass. Luminaire to be suspended using brackets (Ø27G), post top, or wall mounted. Tool-free electrical connection via 2 x 2.5 mm² terminal block. Equipped with 50% power reduction circuit, effective 3 hours before and 5 hours after a calculated midnight. Pre-wired with 8m, 4 core cable. Complete with 4000K LED

Must be used in conjunction with a canopy (see Victoria Canopies section), to be ordered separately.

Dimensions: Ø605 x 355 mm
Luminaire input power: 21 W
Weight: 5.66 kg
Scx: 0.144 m²



TLG_VCTA_F_PDB.jpg

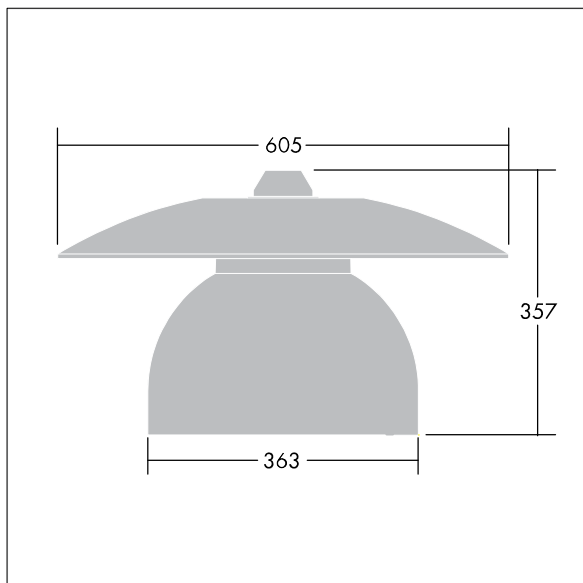

TLG_VCTA_M_SWLD1.wmf

This product contains light sources of energy efficiency classes D, F.

All values marked with an * are rated values. Thorn uses tried and tested components from leading suppliers, however there may be isolated instances of technology-related failures of individual LEDs during the rated product lifetime. International standards set the tolerance in initial flux and connected load at ±10%. Unless stated otherwise, the values apply to an ambient temperature of 25°C.

Thorn Lighting is constantly developing and improving its products. The right is reserved to change specifications without prior notification or public announcement.
© Thorn Lighting