

96632486 KAT RD SE 1200-840 MWS

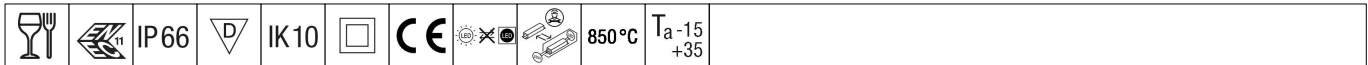

Katona

A round functional LED luminaire with deep body for side entry wiring capability, can be used with up to Ø20mm surface mounted conduit. Fixed output LED driver. Body: polycarbonate. Diffuser: opal polycarbonate. Class II electrical, IP66, IK10. With integral motion sensor for on/off control. Complete with 4000K LED. Suitable for direct mounting to wall or ceiling. Loop-in, loop-out is possible for cables up to 2.5mm². BESA compatible.

Dimensions: Ø328 x 84 mm
 Luminaire input power: 11.7 W
 Luminaire luminous flux: 1250 lm
 Luminaire efficacy: 107 lm/W
 Weight: 0.05 kg

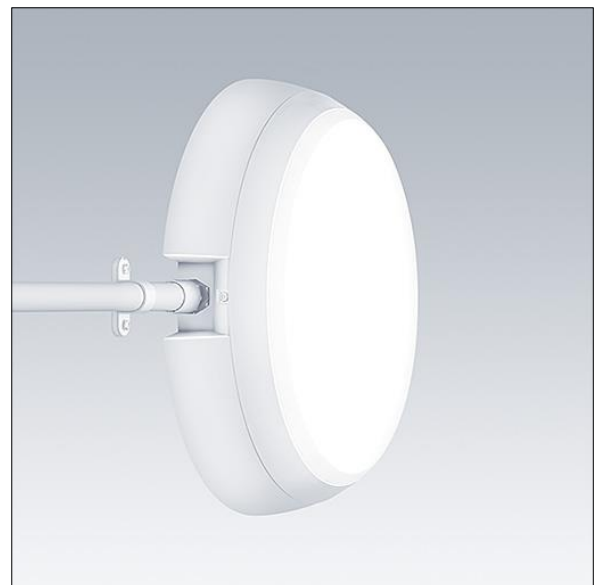

TLG_KATO_F_RD_deep_PDB.jpg



TLG_KATO_M_RD_FRAME_LDS.wmf

This product contains a light source of energy efficiency class C.

Katona

96632486 KAT RD SE 1200-840 MWS

THORN