

E7748624 / 92916455 PLI D 24L35-830 R/S BS 3550 T60 CL2 ->

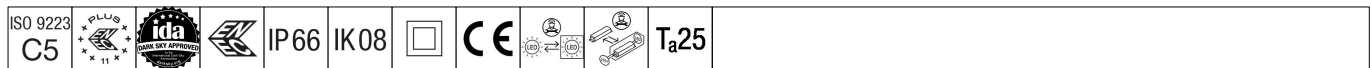

Plurio

Plurio Indirect: A decorative post-top LED lantern with radially symmetric distribution. LED driver with 24 LEDs driven at 350mA. Class II electrical, IP66, IK08. Base: cast aluminium, powder coated anthracite (close to RAL7043). Canopy: disc shape, aluminium, textured anthracite (close to RAL7043). Diffuser: UV stabilised, clear polycarbonate with anti-glare prisms. Indirect, reflector based optic. Equipped with 50% power reduction circuit, effective 3 hours before and 5 hours after a calculated midnight. It can be deactivated at installation with an easily accessible internal switch. Complete with 3000K LED. Post top mounting to Ø60mm column. Pre-wired with 4m cable.

Upward lighting emissions below 1%.

Dimensions: Ø618 x 453 mm
 Luminaire input power: 26 W
 Luminaire luminous flux: 2782 lm
 Luminaire efficacy: 107 lm/W
 Weight: 6.7 kg
 Scx: 0.151 m²



TLG_PLRL_F_IDC_ANT.jpg

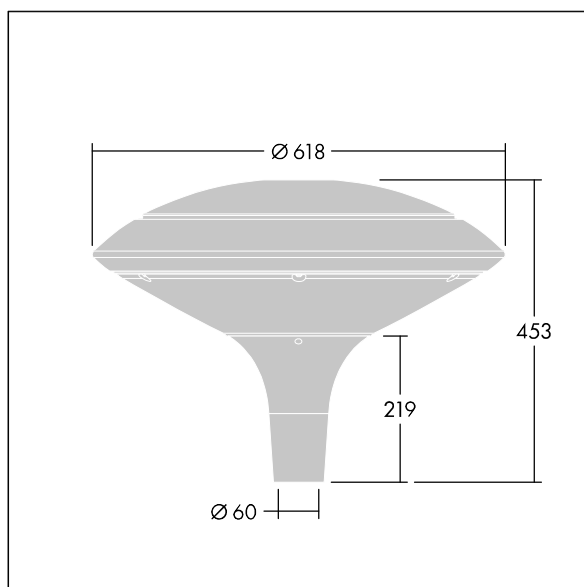

TLG_PLRL_M_IDC_T60.wmf

This product contains a light source of energy efficiency class D.

Plurio

E7748624 / 92916455 PLI D 24L35-830 R/S BS 3550 T60 CL2 ->

THORN