

ISO 9223 C5	UK CA	IP66	IK08		CE			Ta45
----------------	----------	------	------	--	----	--	--	------

Isaro

A discrete and flexible road and street lantern with durable high performance. Programmable LED driver, set for fixed output, driving 36 LEDs at 500mA. Body: small size, die-cast aluminium (EN AC-44300), powder coated textured light grey 150 (close to RAL9006). Shaft: unpainted. Cover: Extra White glass. Fixings: stainless steel with anti-galvanic treatment. Narrow Road optic, with Colour Rendering Index min.: 70, Correlated colour temperature*: 4000 Kelvin LEDs supplied. Class II electrical, Impact strength: IK08, IP66, Ta max.: 45°C. Supplied with Ø60mm spigot adaptor pre-fitted for post-top, 5° tilt. Pre-wired with 8m, 1.5mm² H07RN-F cable. Equipped with 1 Zhaga socket.

Dimensions: 550 x 238 x 157 mm
 Luminaire input power: 54.5 W
 Luminaire luminous flux: 8747 lm
 Luminaire efficacy: 160 lm/W
 Weight: 4.82 kg
 Scx: 0.041 m²



TLG_ISLC_F_S_ZU_SR.jpg

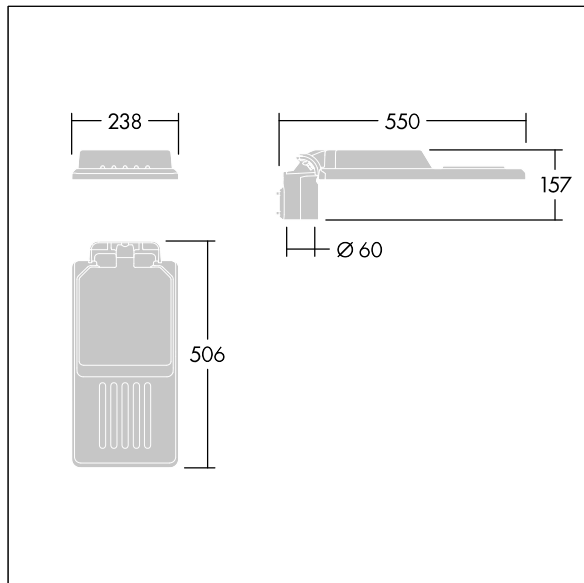

TLG_ISLC_M_SMTP60.wmf

All values marked with an * are rated values. Thorn uses tried and tested components from leading suppliers, however there may be isolated instances of technology-related failures of individual LEDs during the rated product lifetime. International standards set the tolerance in initial flux and connected load at ±10%. Unless stated otherwise, the values apply to an ambient temperature of 25°C.

Isaro

E7728392 / 92938809 IS S 36L50 740 NR ZU CL2 WS8 T60F GY-S

THORN