

Novaline Style

96635517 NOVS S 1400-840 DI HF BK

THORN

IEC EN 60598-1 RG 1	RoHS	UK CA	IP54	D	halogen	IK08	CE	850°C	T _a -15 +25
---------------------------	------	----------	------	---	---------	------	----	-------	---------------------------

Novaline Style

Decorative circular luminaire with small body. Low indirect component for wall and ceiling illumination. Electronic, fixed output control gear. Aesthetic trim of the luminaire made of polycarbonate in black. Diffuser: opal polycarbonate. Class II electrical, IP54. Complete with 4000K LED.

Dimensions: Ø320 x 69 mm
Luminaire input power: 9.7 W
Luminaire luminous flux: 1400 lm
Luminaire efficacy: 144 lm/W
Weight: 1.68 kg



TLG_NOVS_F_3BK.jpg

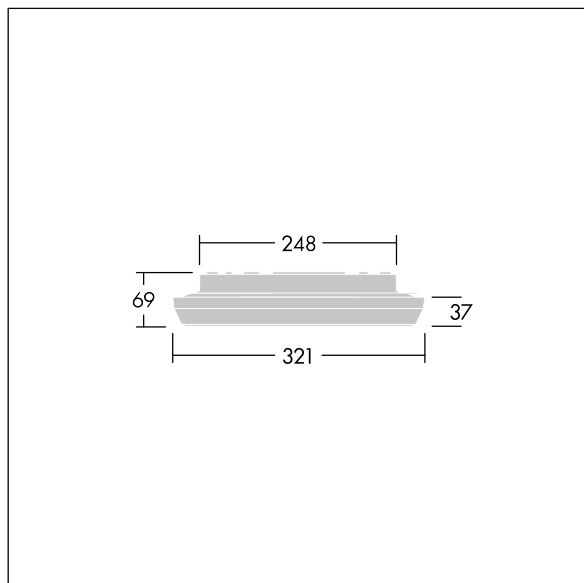

TLG_NOVS_M_LD300.wmf

This product contains a light source of energy efficiency class C.

All values marked with an * are rated values. Thorn uses tried and tested components from leading suppliers, however there may be isolated instances of technology-related failures of individual LEDs during the rated product lifetime. International standards set the tolerance in initial flux and connected load at $\pm 10\%$. Unless stated otherwise, the values apply to an ambient temperature of 25°C.

Thorn Lighting is constantly developing and improving its products. The right is reserved to change specifications without prior notification or public announcement.
© Thorn Lighting

Novaline Style

96635517 NOVS S 1400-840 DI HF BK

THORN