

Candle

96679081 CN 18L70 730 RSC CL2 W3 ANT

ISO 9223 C5	IP66	IK10					T _a 25
----------------	------	------	--	--	--	--	-------------------

Candle

Slim lighting column with 18 LEDs driven at 700mA with Radial symmetrical comfort light distribution. Fixed output LED driver. Class II electrical, IP66, IK10. Base: die-cast aluminium (EN AC-44300). Finish: powder coated aluminium, texturized anthracite (close to RAL7043). Diffuser: UV stabilised clear polycarbonate. Pre-wired with 3m cable. Column to be ordered separately. Complete with 3000K LED.

Dimensions: Ø234 x 559 mm
 Luminaire input power: 39 W
 Weight: 4.84 kg
 Scx: 0.06 m²
 Luminaire efficacy: 100 lm/W



TLG_CNDL_F_2.jpg

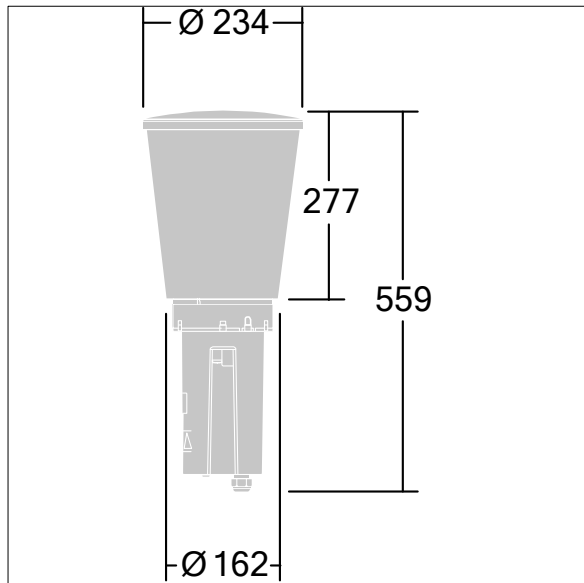

TLG_CNDL_M_HEAD.wmf

This product contains a light source of energy efficiency class D.

All values marked with an * are rated values. Thorn uses tried and tested components from leading suppliers, however there may be isolated instances of technology-related failures of individual LEDs during the rated product lifetime. International standards set the tolerance in initial flux and connected load at ±10%. Unless stated otherwise, the values apply to an ambient temperature of 25°C.

Candle

96679081 CN 18L70 730 RSC CL2 W3 ANT

THORN