

Areaflood Pro 2

92998081 AFP2 L 144L70 740 A4 H CLO BS 3525 SP ->

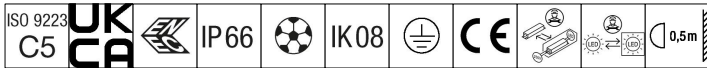

Areaflood Pro 2

A compact, lightweight, general purpose LED area floodlight. With large body. LED converter driving 144 LEDs at 700mA with Asymmetrical 40° light distribution. IP66, IK08, Class I electrical. Body: die-cast aluminium (EN AC-44300), Light grey 150 sanded textured (close to RAL9006). High transmission Glass. Enclosure: 5mm thick toughened glass. Reversible mounting stirrup supplied, optional spigot adaptors available separately for post top mounting. BSxyz: Autonomous, physically disconnectable, bi-power reduction (x: hours before midnight, y: hours after midnight, zz: reduction (%)). Driver programmed for constant light output. Fitted with 10kV surge protection. Pre-wired with 3m, 1.5mm² H07RN-F cable. Complete with 4000K LED.



TLG_AFP2_F_L_1.jpg

Dimensions: 729 x 360 x 115 mm
 Luminaire input power: 298 W
 Luminaire luminous flux: 48099 lm
 Luminaire efficacy: 161 lm/W
 weight: 14.18 kg
 Scx: 0.068 m²

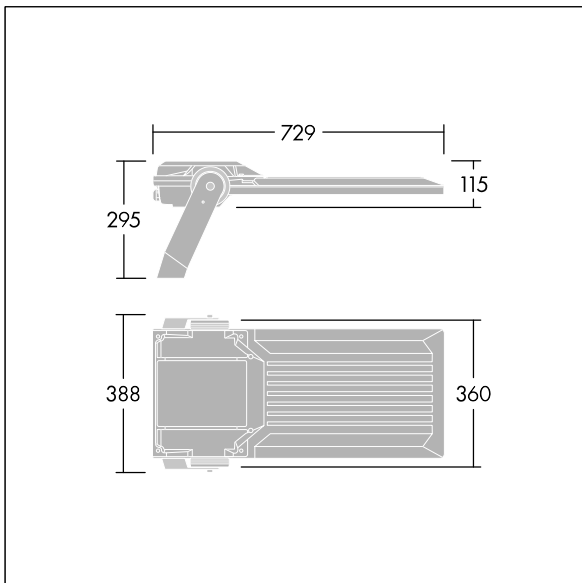

TLG_AFP2_M_L.wmf

This product contains light sources of energy efficiency classes D, E.

All values marked with an * are rated values. Thorn uses tried and tested components from leading suppliers, however there may be isolated instances of technology-related failures of individual LEDs during the rated product lifetime. International standards set the tolerance in initial flux and connected load at ±10%. Unless stated otherwise, the values apply to an ambient temperature of 25°C.